

Dual

Dual CV 1600



Schaltbild

Wiring Diagram

Schéma de branchement

Schakelschema

Esquema de conexiones

Kopplingschema

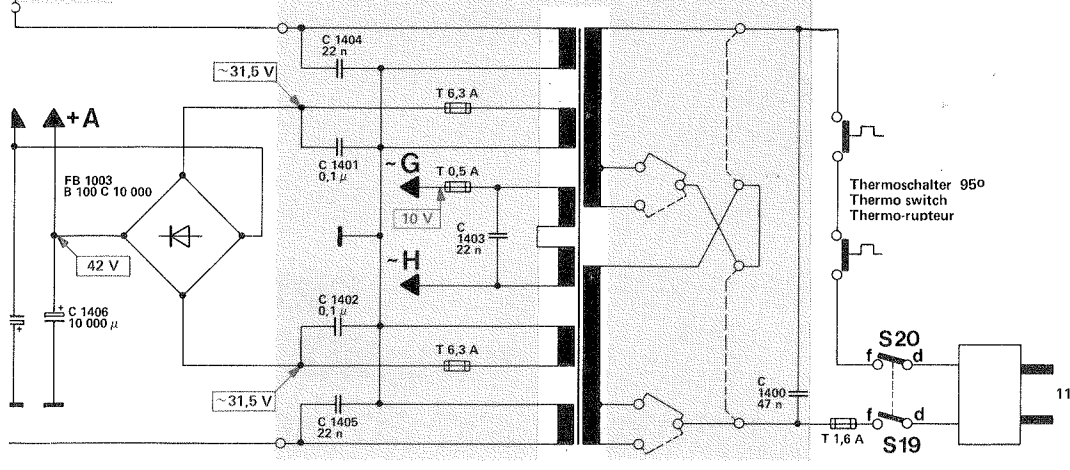
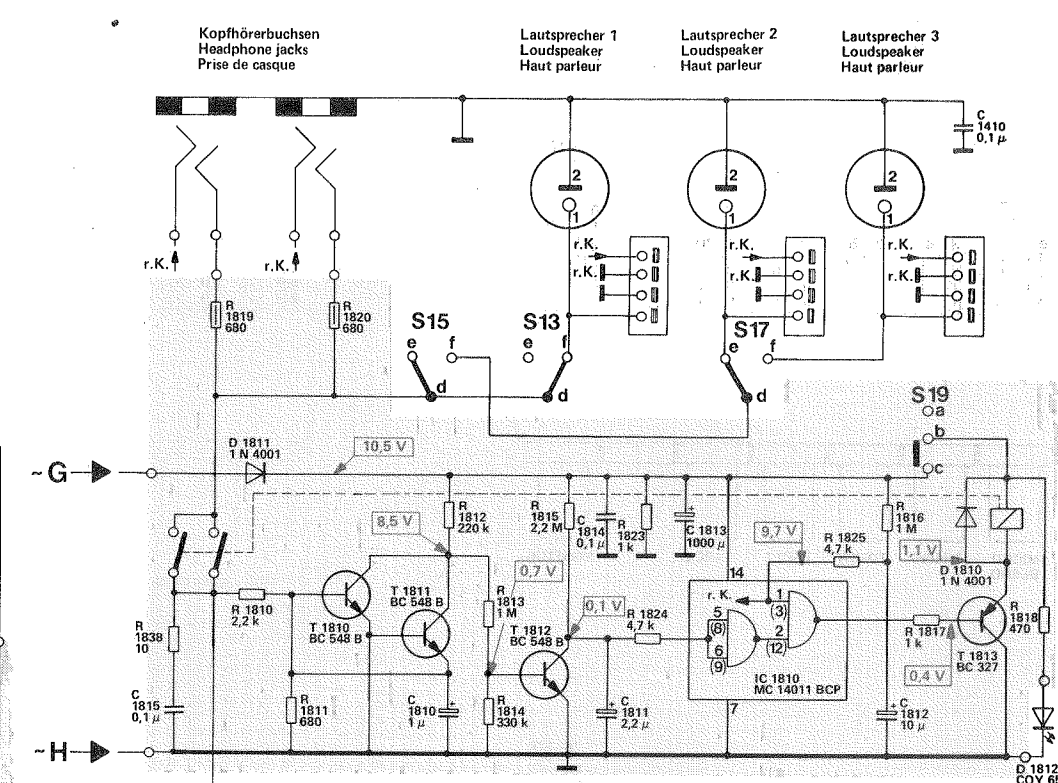
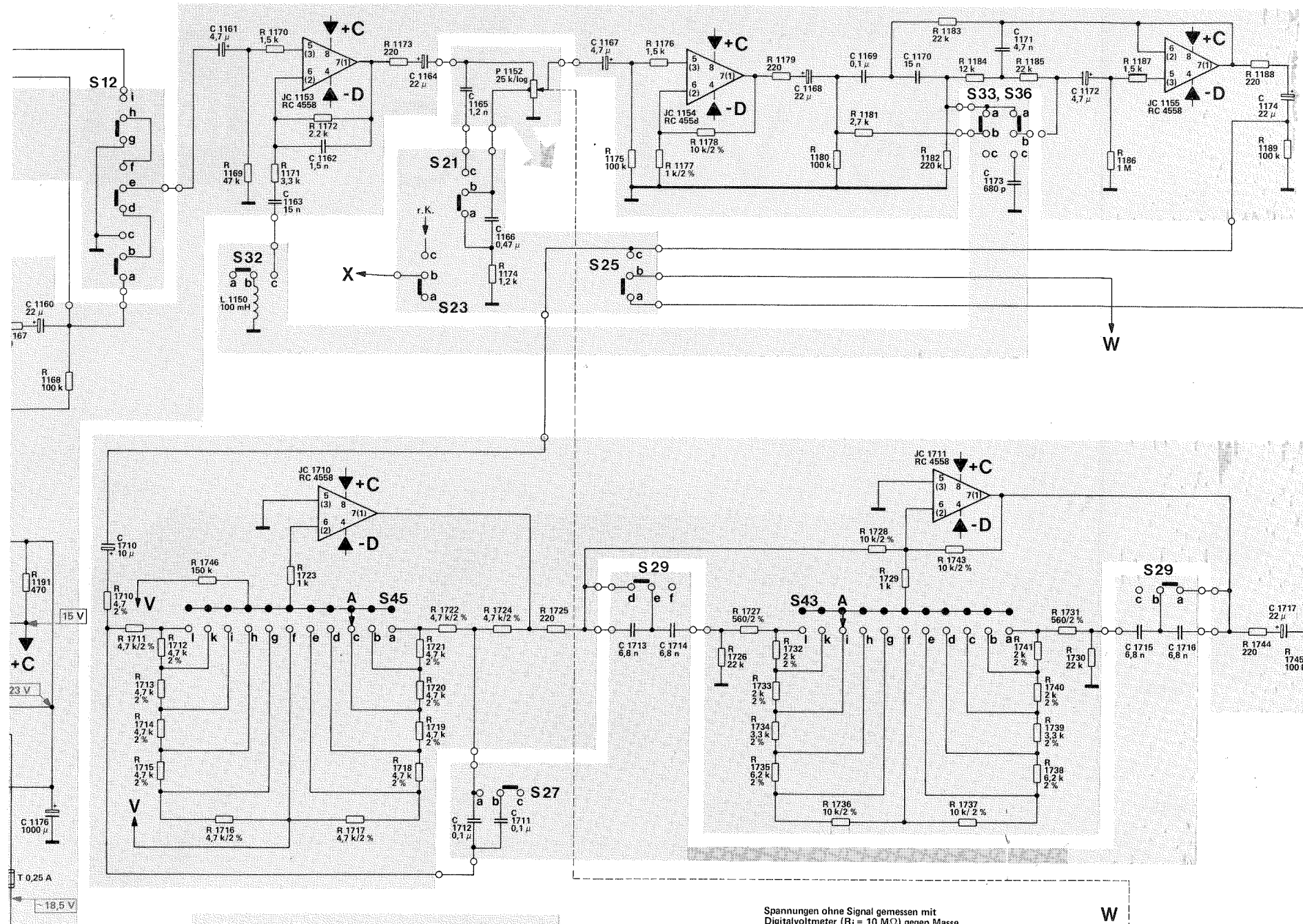

Spannungen ohne Signal gemessen mit Digitalvoltmeter ($R_i = 10 \text{ M}\Omega$) gegen Masse.
 Voltages without signal measured with digital voltmeter ($R_i = 10 \text{ M}\Omega$) to ground.
 Tensions mesurées sans signal avec voltmètre digital ($R_i = 10 \text{ M}\Omega$) contre masse.

Belastbarkeit der Widerstände
 Resistor loading capacity
 Capacité admissible de charge des résistances

- $\text{---} = 0,25 - 0,30 \text{ W}$
- $\text{---} = 0,5 \text{ W}$
- $\text{---} = 4 \text{ W}$

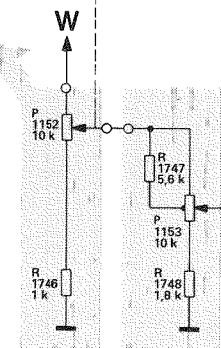

r.K. = Rechter Kanal
 Right channel
 Canal droit

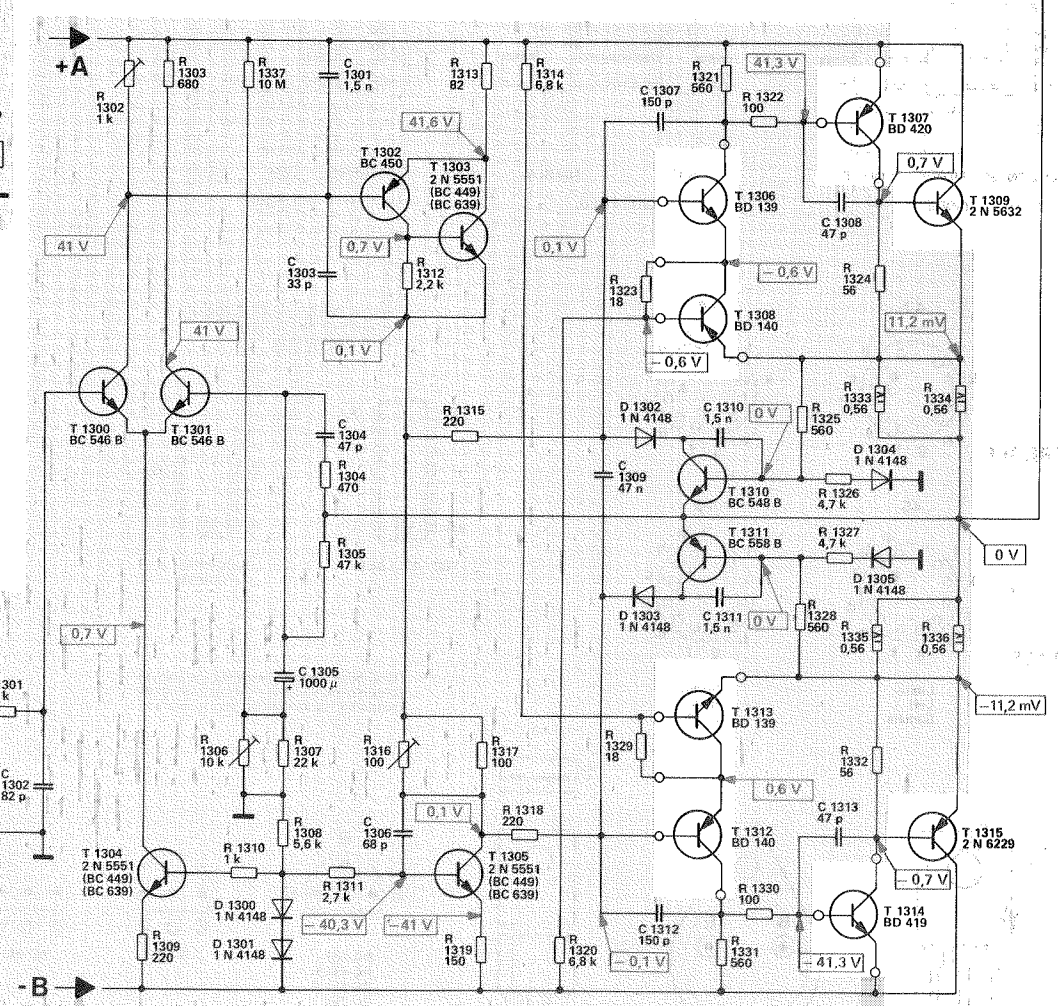

67	1160	1170	1171	1172	1173	1174	1175	1176	1177	1178	1179	1180	1181	1182	1183	1184	1185	1186	1187	1188	1189	1190	1191	1192	1193	1194	1195	1196	1197	1198	1199	1200						
1160	1170	1171	1172	1173	1174	1175	1176	1177	1178	1179	1180	1181	1182	1183	1184	1185	1186	1187	1188	1189	1190	1191	1192	1193	1194	1195	1196	1197	1198	1199	1200							
12	13	14	15	16	17	18	19	20	21	22	23	24	25	26	27	28	29	30	31	32	33	34	35	36	37	38	39	40	41	42	43	44	45	46	47	48	49	50

Änderungen vorbehalten / Alterations reserved / Sous réserve de modifications

Ausgabe 4/Oktober 1977

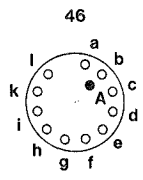
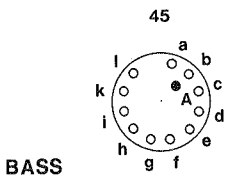
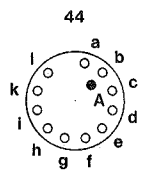
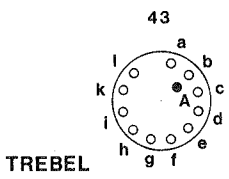
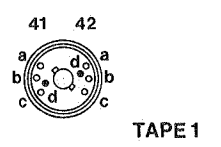
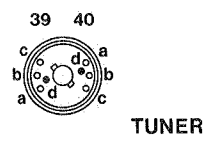
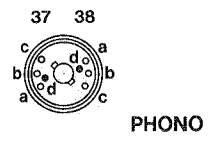
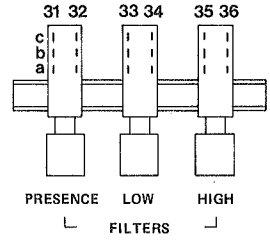
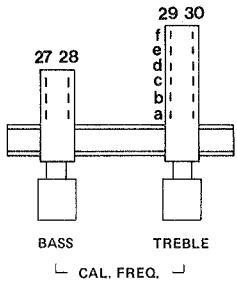
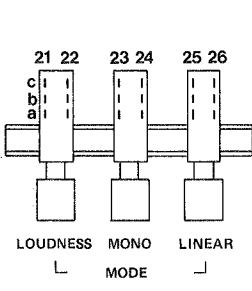
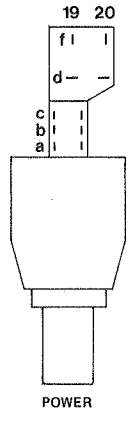
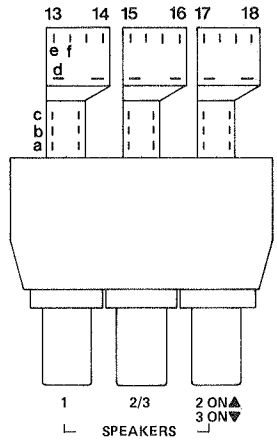
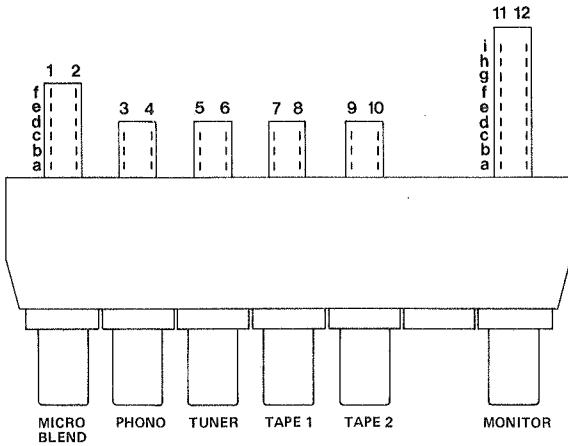

Links
Left
Gauche

Rechts
Right
Droit

IC
von der Bestückungsseite gesehen
as seen from the top side
vu du côté éléments

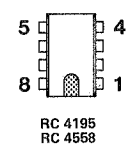
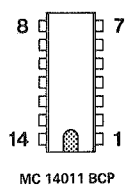

Transistoren von der Anschlußseite gesehen
Transistors as seen from the connecting side
Transistors vus du côté des connexions

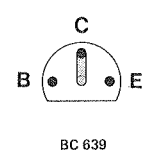
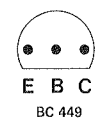
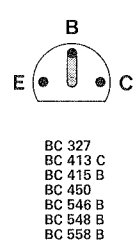
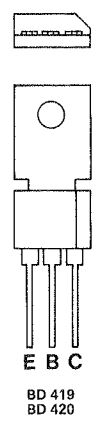
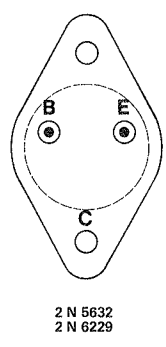
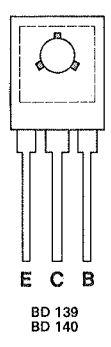

S W S S S E K

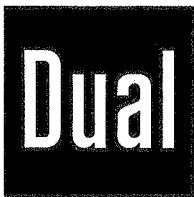

Dual Gebrüder Steidinger

242 726-4 2.5/1077

7742 St. Georgen/Schwarzwald

Printed in Germany by Dual